

X-10 POWERHOUSE™

Thermostat Set-Back Control System Model TH2807

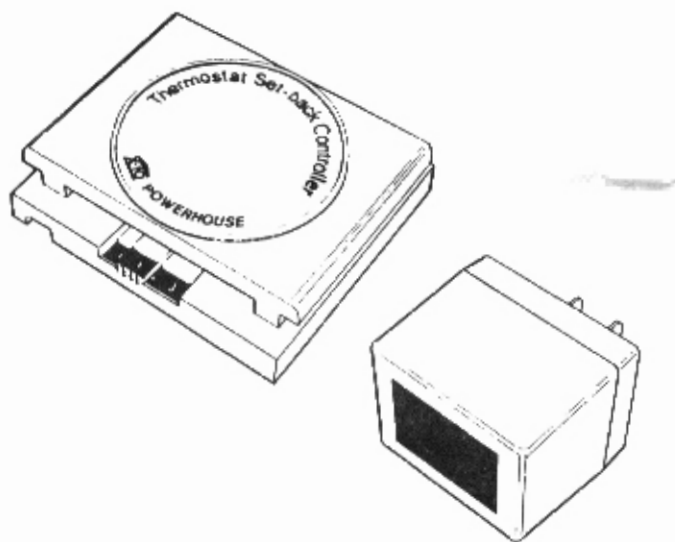

Owner's Manual

WHAT IT DOES

The Thermostat Set-Back Controller regulates central heating and air conditioning controlled by ANY thermostat. When used with an X-10 Timer you can program your central heating to automatically reduce the temperature of your home when you're sleeping or away from home. In the summer months the Thermostat Set-Back Controller can regulate your central air conditioning system to help save energy dollars and still pre-cool your home before you return. When used with the X-10 Telephone Responder you can call from any touch-tone phone in the world and instantly warm up or pre-cool your home ready for your arrival – great for summer homes or winter ski cottages

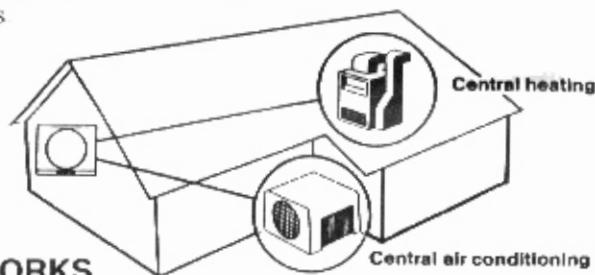

HOW IT WORKS

You install the Thermostat Set-Back Controller in minutes without touching your existing thermostat wiring. It simply mounts on the wall under your existing thermostat using the double sided tape supplied. You plug the power supply into an X-10 Appliance Module or Wall Outlet Module (sold separately). The Appliance Module or Wall Outlet Module then receives signals over your existing house wiring from any X-10 Remote Control, Timer or Telephone Responder. It's that simple!

A variety of X-10 Controllers are available for use with the Set-Back Thermostat. Some of these are described below:

Mini Timer MT522

A Controller, Timer and Alarm Clock all in one! Programs up to 4 modules to go on and off at specific times, twice a day. Controls 8 modules instantly. Dims lights too.

Maxi Controller SC503

Lets you control up to 16 X-10 Modules at the touch of a button from anywhere in the house. Dims lights too!

Mini Controller MC460

Lets you control up to 8 X-10 Modules at the touch of a button from anywhere in the house. Dims lights too!

Home Control Interface CP290

Set up from an IBM or Mac to control up to 256 X-10 Modules. Cable and software for DOS & Windows or Mac included.

Telephone Responder TR551

Lets you control up to 10 lights and appliances from any outside touch-tone telephone.

Wireless Remote Control System RC6500

Lets you control 2 X-10 modules from inside or outside your home. Can be expanded to control 16 modules and also dim and brighten Lamp Modules and Wall Switch Modules by adding an RT504 Remote Control.

USA X-10 (USA) Inc.,

91 Ruckman Rd., Closter, NJ 07624
(201) 784-9700, Fax (201) 784-9464

Canada X-10 Home Controls Inc.,

1200 Aerowood Drive, Unit 20,
Mississauga, Ontario, Canada L4W 2S7.
(905) 624 4446, Fax (905) 625-8480

Printed in Hong Kong TH2807-394

INSTALLATION

Tools Required: Installation of the Thermostat Set-Back Controller will require a small screwdriver and a wire stripper or pliers with built-in wire stripper.

1. Secure the Thermostat Set-Back Controller to the wall approximately 1/4" below your existing thermostat. It can be attached either by removing the backing from the double-sided tape, or by using mounting screws. If you are using mounting screws, remove the front plastic housing to expose the recessed screw holes located on the rear housing. After mounting the unit to the wall replace the front plastic housing.

2. Attach the adhesive-backed wire down the wall.

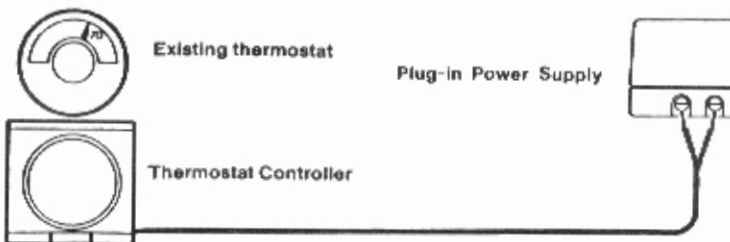

3. Continue to attach the wire along the baseboard to the nearest wall outlet. Cut the wire to the proper length and strip off the insulation to expose about 1/2" bare ends. Connect the ends of the wire to the screw terminals on the plug-in power supply by wrapping the wire under the screw heads and tightening the screws.

INSTALLATION (CONTINUED)

4. Plug the power supply into and X-10 Appliance Module (AM486, 2 pin or AM466, 3 pin grounded) or Wall Outlet Module (SR227).
5. Set the Housecode dial on the Module to match the letter set on your X-10 Remote Control, Timer, or Telephone Responder (sold separately).
6. Set the Unit Code dial on the Module to any unused number between 1 and 16.

You can now set-back your thermostat from any X-10 Remote Control, Timer, or Telephone Responder. See instructions supplied with X-10 Controllers and Timers etc. for more information.

CONTROLLING CENTRAL HEATING

1. Set your thermostat to the temperature you want your home to be during non set-back hours (for example 70 degrees when you are home).
2. Set the selector switch on the Set-Back Controller for the amount of temperature reduction you want during set-back hours (when you are not home, or when you are asleep).

- Lo Reduces the temperature approximately 5° F
- M Reduces the temperature approximately 10° F.
- Hi Reduces the temperature approximately 15° F.

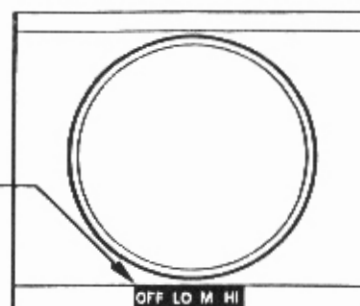

The actual amount of temperature reduction will vary depending on the type of thermostat and the distance between the thermostat and the Set-Back Controller. Try different settings to achieve the temperature you want.

When the Appliance Module is ON, a low voltage is applied to the Set-Back Controller which in turn supplies a small amount of local heat under your thermostat (5, 10, or 15 degrees). This "fools" your thermostat into thinking the room is hotter than it really is (by 5, 10, or 15 degrees). The result is that with a thermostat setting of say 70° F and the set-back set to Medium (10 degrees reduction) the actual room temperature will be kept at 60 degrees when the Appliance Module is ON. When the Appliance Module is OFF the room temperature will rise again to the setting on your thermostat (70° F). Therefore the Appliance Module should be programmed to be OFF during the day (when you want it warmer) and ON when you are sleeping or away from the house (when you want it cooler).

CONTROLLING CENTRAL AIR CONDITIONING

1. Set your thermostat to the *maximum* temperature you want your home to be when you are *not* home, or when you are sleeping (for example 80 degrees).
2. Set the selector switch on the Set-Back Controller for the amount of temperature reduction you want when you *are* home during the day.

- Lo Reduces the temperature approximately 5° F.
- M Reduces the temperature approximately 10° F.
- Hi Reduces the temperature approximately 15° F.

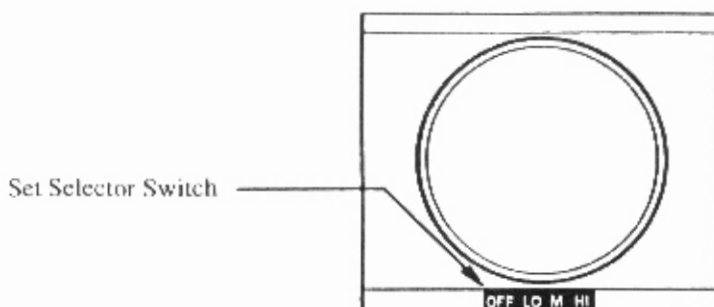



The actual amount of temperature reduction will vary depending on the type of thermostat and the distance between the thermostat and the Set-Back Controller. Try different settings to achieve the temperature you want.

When the Appliance Module is ON, the heat created by the Set-Back Controller again "fools" your thermostat into thinking the room is hotter than it really is (by 5, 10, or 15 degrees).

The result is that with a thermostat setting of say 80° F and the set-back set to Medium (10 degrees reduction) the actual room temperature will be kept at 70 degrees when the Appliance Module is ON. When the Appliance Module is OFF the room temperature will rise again to the setting on your thermostat (80° F).

Therefore the Appliance Module should be programmed to be OFF when the house is unoccupied, or when you are asleep (when you want it warmer) and ON when you are home during the day (when you want it cooler).

© 1994 X-10 (USA) Inc.
All Rights Reserved

 is a registered trade mark of X-10 (USA) Inc.
 is a trade mark of X-10 (USA) Inc.